

# Logic/Motion controller Modicon M262

IIoT-ready for performance machines

Catalog

June 2019



**Schneider**  
Electric

# Quick access to product information

## Get technical information about your product



Each commercial reference presented in a catalog contains a hyperlink. Click on it to obtain the technical information of the product:

- Characteristics, Dimensions and drawings, Mounting and clearance, Connections and schemas, Performance curves
- Product image, Instruction sheet, User guide, Product certifications, End of life manual

## Find your catalog



- > With just 3 clicks, you can reach the Industrial Automation and Control catalogs, in both English and French
- > Download Digi-Cat with this [link](#)

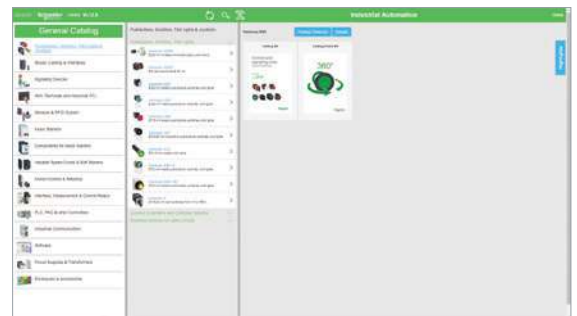

- Updated quarterly
- Embeds product selectors and configurators, 360° images, training centers
- Optimized search by commercial reference

## Select your training



- > Find the right [Training](#) for your needs on our Global website
- > Locate the training center with the selector tool, using this [link](#)



# Content

## Logic/Motion controller – Modicon M262

IIoT-ready for performance machines

*Introduction to EcoStruxure Machine* ..... page 2

*Selection guide: controllers for industrial machines* ..... page 4

*Machine automation* ..... page 6

### ■ Presentation

- Modicon M262, the IIoT-ready controllers for Logic & Motion machines ..... pages 8 and 9
- Targeted applications ..... page 10
- Embedded IO ..... page 10
- Extended I/O with modular I/O systems ..... page 10
- Equipment ..... page 10
- Performance ..... page 11
- Certifications and Standards ..... page 11
- Environmental characteristics ..... page 11
- Supply characteristics ..... page 11
- Programming ..... page 11
- Housing ..... page 12
- Connecting Modicon M262 controllers
  - to devices ..... page 12
  - to the Modicon TM3 optimized I/O system ..... page 12
  - to Modicon TM5 and TM7 High-performance I/O systems ..... page 13
  - to Modicon TM5 and TM7 safety I/O systems ..... page 13
- Embedded communication, additional communication ..... page 14
- Embedded Safety ..... page 15
- *Selection guide: Modicon M262 controllers* ..... pages 16 and 17

### ■ Description

- Modicon M262 controllers ..... page 18
- TMS Smart communication modules ..... page 18

### ■ References

- Modicon M262 Logic/Motion controllers ..... page 19
- TMS smart communication modules ..... page 19
- Spare parts, accessories ..... page 19
- Expansion modules ..... page 19

### ■ Tested Validated & Documented Architecture

- Modicon M262L logic controller ..... page 20
- Modicon M262M motion controller ..... page 21

- **Product reference index** ..... page 22

To be competitive in today's digital era, machine builders must be innovative. Smart machines, those that are better connected, more flexible, more efficient, and safe, are enabling machine builders to innovate in ways never before possible.

EcoStruxure, Schneider Electric's open, IoT-enabled architecture and platform, offers powerful solutions for the digital era. As part of this, EcoStruxure Machine brings powerful opportunities for machine builders and OEMs, empowering them to offer smart machines and compete in the new, digital era.

EcoStruxure Machine brings together key technologies for product connectivity and edge control on premises, and cloud technologies to provide analytics and digital services. EcoStruxure Machine helps you bring more innovation and added value to your customers throughout the entire machine life cycle.

**Innovation at Every Level for Machines is full systems across three layers:**

- Connected products  
Our connected products for measuring, actuating, device level monitoring, and control adhere to open standards to provide unmatched integration opportunities and flexibility
- Edge Control  
We are IIoT-ready with a proven set of tested and validated reference architectures that enable the design of end-to-end open, connected, and interoperable systems based on industry standards. Ethernet and OPC UA facilitates IT/OT convergence meaning machine builders reap benefits from web interfaces and cloud.

- Apps, Analytics & Services  
Seamless integration of machines to the IT layer allows the collection and aggregation of data ready for analysis – for machine builders and end users alike this means increased uptime and the ability to find information faster for more efficient operations and maintenance.

**These levels are completely integrated from shop floor to top floor. And we have cloud offers and end-to-end cybersecurity wrapped around.**

EcoStruxure Machine makes it easier for OEMs/ machine builders to offer their customers smarter machines. The advent of smart machines is driven by the changing needs of end users:

- Evolving workforce
- Reducing costs
- Dynamic markets
- Shorter life cycles
- Prioritizing safety and cybersecurity

EcoStruxure Machine provides one solution for the whole machine life cycle:

- With Smart Design & Engineering the time to market is reduced by up to 30% using our automated engineering and the simulation capabilities
- During Commissioning & Operation of the machine, resources such as energy, material and loss can be improved, and with seamless integration to the IT world efficiency can be improved by up to 40%
- Smart Maintenance & Services reduces the time for corrective actions up to 50%

# EcoStruxure™ Machine

Innovation At Every Level



\* The Schneider Electric industrial software business and AVEVA have merged to trade as AVEVA Group plc, a UK listed company. The Schneider Electric and Life is On trademarks are owned by Schneider Electric and are being licensed to AVEVA by Schneider Electric.

# Logic/Motion controller Modicon M262

IIoT-ready for performance machines  
Controllers for industrial machines

Applications	Type	Logic controller			Logic/Motion controller		Motion controller
	Specification	For hardwired architectures	For performance-demanding applications		For modular and distributed architectures	IIoT ready for performance machines	For automating machines/lines with 0 - 130 servo or robot axes
							
<b>Performance</b>		0.2 µs/inst	22 ns/inst		22 ns/inst	3...5 ns/inst	0.5...2 ns/inst
<b>Memory</b>		640 KB RAM, 2 MB Flash	64 MB RAM, 128 MB Flash		64 MB RAM, 128 MB Flash	256 MB RAM, 256 MB Flash	128 KB to 256 KB NV RAM 512 MB DDR2 to 1 GB DDR3L
<b>Supply voltage</b>		24 V ~ or 100...240 V ~	24 V ~ or 100...240 V ~		24 V ~	24 V ~	24 V ~
<b>Communication fieldbus and networks</b>	Embedded	<ul style="list-style-type: none"> <li>■ EtherNet/IP</li> <li>■ RS 232/RS 485 serial link</li> <li>■ USB mini-B programming port</li> </ul>	<ul style="list-style-type: none"> <li>■ Ethernet</li> <li>■ CANopen (master) and SAE J1939</li> <li>■ 2 serial links</li> <li>■ USB mini-B programming port</li> </ul>		<ul style="list-style-type: none"> <li>■ EtherNet/IP</li> <li>■ CANopen (master) and SAE J1939</li> <li>■ Serial link</li> <li>■ USB mini-B programming port</li> </ul>	<ul style="list-style-type: none"> <li>■ EtherNet/IP</li> <li>■ Sercos III</li> <li>■ Modbus TCP</li> <li>■ Serial link</li> <li>■ USB mini-B programming port</li> </ul>	<ul style="list-style-type: none"> <li>■ EtherNet/IP</li> <li>■ Sercos III</li> <li>■ CANopen</li> <li>■ Profibus</li> <li>■ Profinet</li> <li>■ EtherCAT</li> </ul>
	Optional	<ul style="list-style-type: none"> <li>■ 1 Serial Line</li> </ul>	<ul style="list-style-type: none"> <li>■ Ethernet</li> <li>■ Profibus DP</li> </ul>		<ul style="list-style-type: none"> <li>■ Ethernet</li> <li>■ Profibus DP</li> </ul>	<ul style="list-style-type: none"> <li>■ Ethernet</li> <li>■ CANopen</li> </ul>	<ul style="list-style-type: none"> <li>■ CANopen</li> <li>■ Profibus DP</li> <li>■ RT-Ethernet</li> </ul>
<b>Embedded I/O</b>	Input types	Up to 40 logic inputs Up to 2 analog inputs	Up to 24 logic inputs		–	4 fast digital inputs	Up to 20 digital inputs Up to 16 touch probe inputs Up to 4 interrupt inputs Up to 2 analog inputs
	Output types	Up to 16 relay outputs Up to 16 transistor outputs	Up to 16 transistor outputs		–	4 fast digital outputs	Up to 16 digital outputs Up to 2 analog outputs
<b>Synchronized axes</b>		–	–		–	Up to 16 synchronized axes	Up to 130 synchronized axes
<b>Configuration software</b>		EcoStruxure Machine Expert-Basic (1)	EcoStruxure Machine Expert V1.1 (2)		EcoStruxure Machine Expert V1.1 (2)	EcoStruxure Machine Expert V1.1	EcoStruxure Machine Expert V1.1 (2)
<b>Compatible expansion I/O module ranges (consult the catalog)</b>	Local I/O	● Modicon TM3 (DIA3ED2140109EN)	● Modicon TM3 (DIA3ED2140109EN)		● Modicon TM3 (DIA3ED2140109EN)	● Modicon TM3 (DIA3ED2140109EN)	–
	Remote I/O	● Modicon TM3 (DIA3ED2140109EN)	● Modicon TM3 (DIA3ED2140109EN)		● Modicon TM3 (DIA3ED2140109EN)	● Modicon TM3 (DIA3ED2140109EN)	–
	Distributed I/O on Ethernet	● Modicon TM3 (DIA3ED2140109EN)	● Modicon TM3 (DIA3ED2140109EN) ● Modicon TM5 (DIA3ED2131204EN)		● Modicon TM3 (DIA3ED2140109EN) ● Modicon TM5 (DIA3ED2131204EN)	● Modicon TM3 (DIA3ED2140109EN) ● Modicon TM5 (DIA3ED2131204EN)	● Modicon TM5 (DIA3ED2131204EN)
	Distributed I/O on CANopen	–	–		–	● Modicon TM5 (DIA3ED2131204EN) ● Modicon TM7 (DIA3ED2140405EN)	● Modicon TM5 (DIA3ED2131204EN) ● Modicon TM7 (DIA3ED2140405EN)
	Distributed I/O on Sercos	–	–		–	● Modicon TM5 (DIA3ED2131204EN)	● Modicon TM5 (DIA3ED2131204EN)
	Safety I/O	⚠ Modicon TM3 (DIA3ED2140109EN)	⚠ Modicon TM3 (DIA3ED2140109EN)		⚠ Modicon TM3 (DIA3ED2140109EN)	⚠ Modicon TM3 (DIA3ED2140109EN) ⚠ Modicon TM5 (DIA3ED2131204EN) ⚠ Modicon TM7 (DIA3ED2140405EN)	⚠ Modicon TM5 (DIA3ED2131204EN) ⚠ Modicon TM7 (DIA3ED2140405EN)
<b>Controller range</b>	<b>Modicon M221/M221 Book</b>	<b>Modicon M241</b>		<b>Modicon M251</b>	<b>Modicon M262</b>	<b>LMC Eco, LMC Pro2</b>	
<b>More details in catalog</b>	<a href="#">DIA3ED2140106EN</a>	<a href="#">DIA3ED2140107EN</a>		<a href="#">DIA3ED2140108EN</a>	<a href="#">DIA3ED2180503EN</a>	<a href="#">DIA7ED2160303EN</a>	

(1) Formerly named SoMachine Basic.

(2) Formerly named SoMachine, EcoStruxure Machine Expert merges both former software ranges, SoMachine and SoMachine Motion.

### Machine Automation

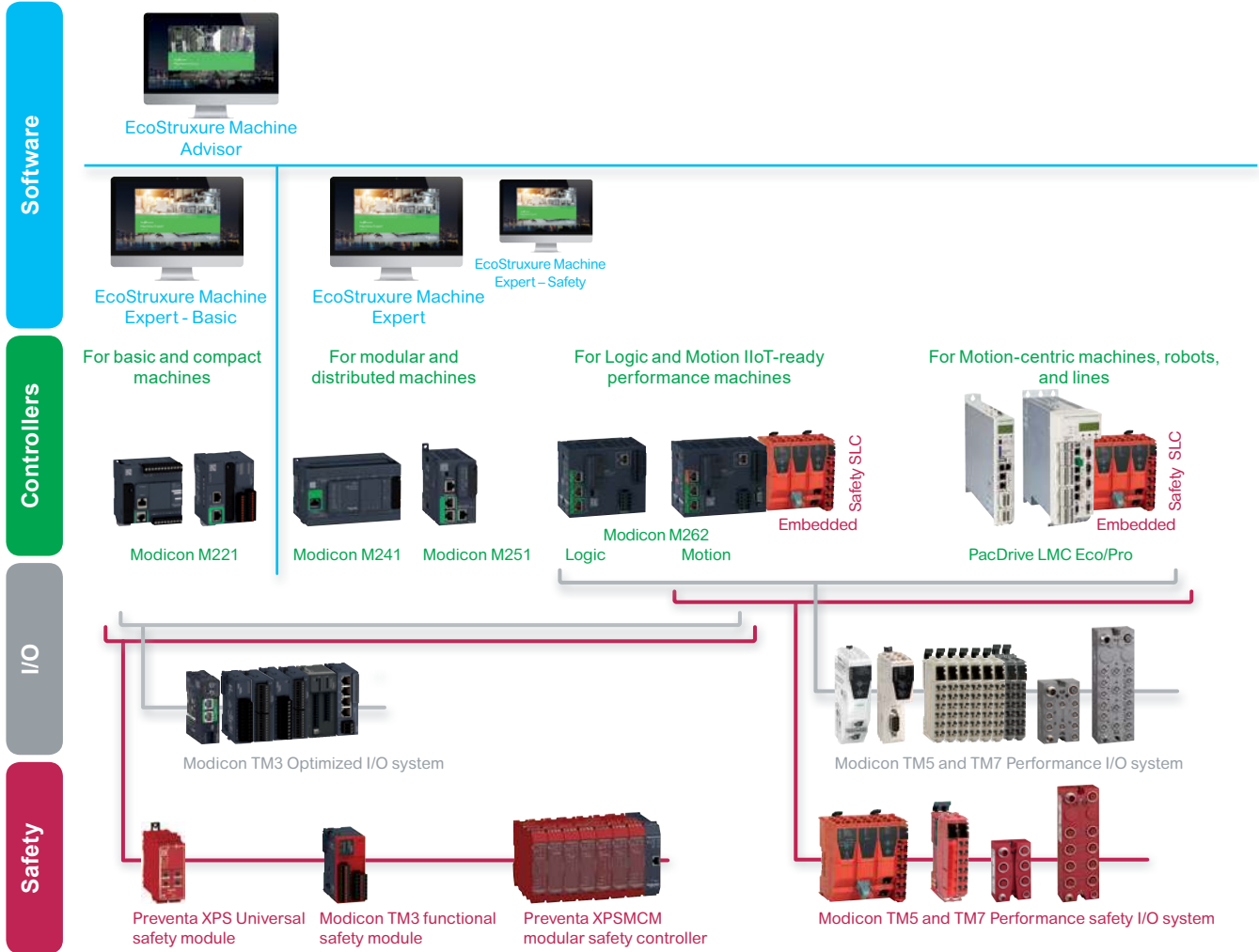

### Machine control

The scalability and consistency of I/O ranges allow you to select the right offer depending on your needs

Embedded Safety provides holistic solutions to Modicon M262 and PacDrive LMC controllers, increasing overall safety demand in Machine Automation

All these devices are managed within a single software, EcoStruxure Machine Expert, a powerful and collaborative engineering environment

- > From basic to motion- and robot-centric machines with the PacDrive 3 offer, Modicon controllers and solutions bring a consistent and scalable response to achieving flexibility, performance, productivity, and digitization.
- > Modicon TM3 Optimized I/O system for more compact and modular machines
- > Modicon TM5 for more performance-demanding machines, with Modicon TM7 for harsh environments; Both Performance I/O ranges (Modicon TM5 and TM7) allow safety functions to be implemented using the Modicon TM5CSLC safety logic controller
- > Preventa XPS Universal safety modules cover a wide range of safety functions, suitable for small applications with 4-5 safety functions, with diagnostic information provided to controllers via a single wire connection
- > Modicon TM3 safety functional modules are suitable for small applications covering E-Stop functions and diagnostics via TM3 bus
- > Preventa XPSMCM modular safety controllers are suitable for medium size applications with up to 20 safety functions and diagnostics via Modbus TCP, EtherNet/IP, EtherCAT, or Profinet
- > **EcoStruxure Machine Expert – Safety** optional add-on for programming safety logic controllers
- > **EcoStruxure Machine Expert – Basic** software for programming Modicon M221 logic controllers: an intuitive standalone environment accessible to basic skilled technicians
- > **EcoStruxure Machine Advisor** is a cloud-based services platform designed for machine builders to track machines in operation worldwide, monitor performance data, and resolve exceptional events, while reducing support costs by up to 50%

#### Machine Automation

#### Comprehensive Schneider offers for machine builders

- > Lexium servo drives, motors, and robotics are designed to control applications ranging from a single independent axis up to high-performance synchronized multi-axis machines requiring high-speed and precise positioning and movements



- > The Lexium offer is designed for a broad range of motion-centric machines in applications such as [Packaging](#), [Material Handling](#), [Material Working](#), [Food and Beverage](#), and [Electronics](#)
- > Schneider Electric has developed Tested Validated & Documented Architectures (TVDA) applicable for generic machine control applications as well as for dedicated segment applications such as Packaging, Material Working, Material Handling, Hoisting, Pumping, or generic [Machine Control applications](#)

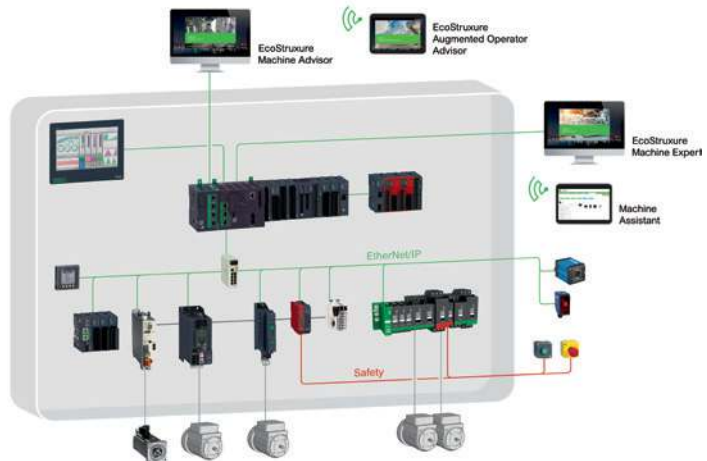

#### Choose Schneider Electric to help secure your investment and benefit from worldwide services at every step of your project

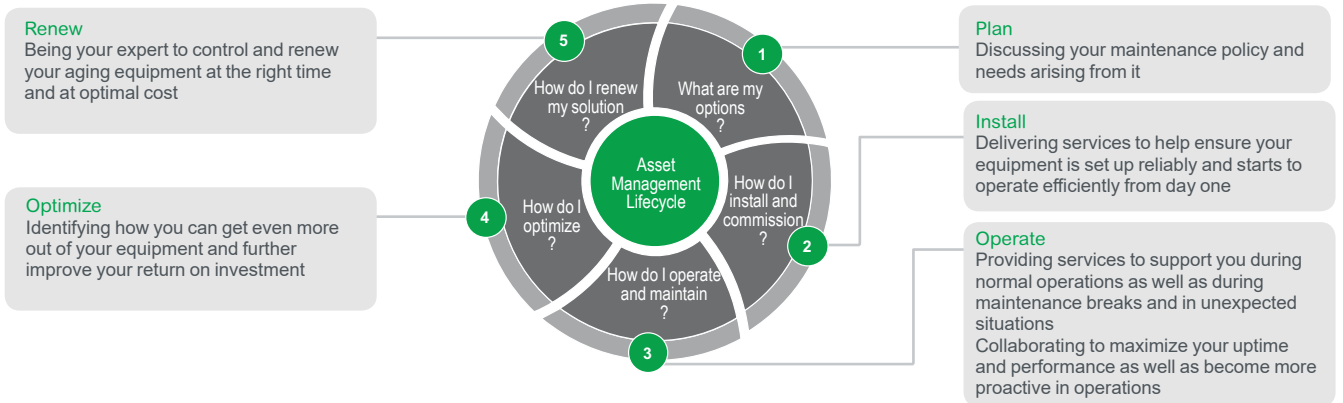

- > From planning and inception to modernization, we help ensure optimal technical and business performance. Our field service engineers combine 30+ years of manufacturer-level experience with the latest technology to bring innovation to every level of our offer, and every step of your project.
- > Our machine control dedicated services empower you to maximize your business infrastructure and face increasingly stringent demands on productivity, safety, equipment availability, and performance optimization.

#### Modicon M262, the IIoT-ready controller for Logic and Motion machines

As a Machine Builder, manufacturing machines with logic or motion control and moving into the Industry 4.0 era, you are looking for a controller with embedded cloud connectivity that offers cybersecurity capability and supports monitoring, analytics, and predictive maintenance.

As the latest polyvalent controller for Logic and Motion with cloud protocols (MQTT, HTTP, JSON, OPC UA) and encryption (TLS), the Modicon M262 is made for you. Modicon controllers are a key part of our EcoStruxure Machine that provides complete architecture from Connected Products, Edge Control to Apps, Analytics, and services.

Modicon M262 controllers embed Industrial Internet of Things (IIoT) protocols and encryption to provide direct cloud connectivity and digital services.

#### Digitization

#### Integrate your machine in any cloud and on-premise environment

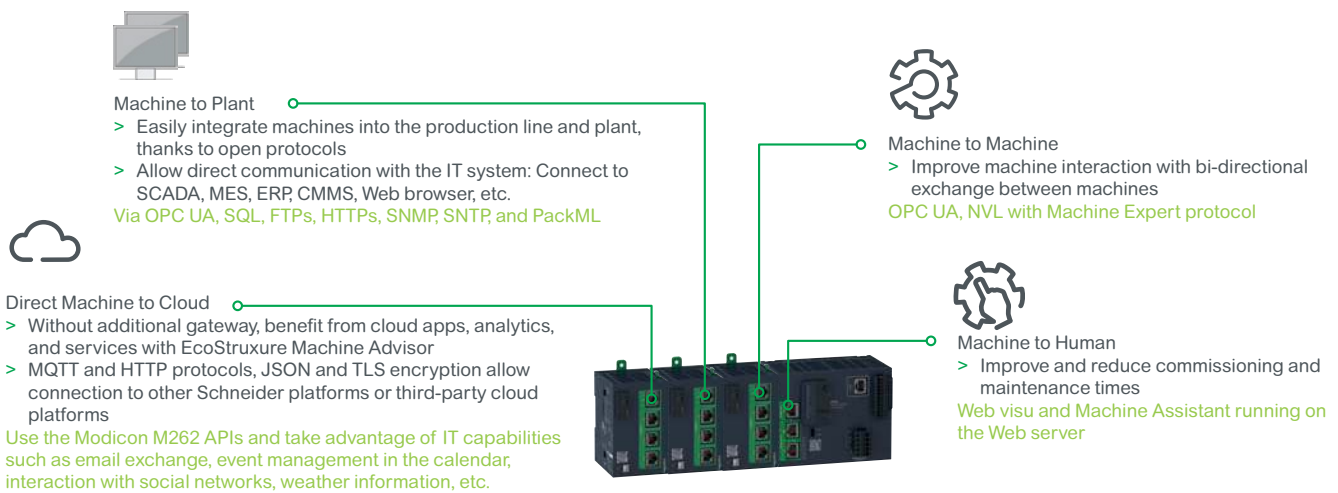

- > Structured networking with up to 5 separate Ethernet ports (2 embedded in the M262, and up to 3 additional ports with TMSES4) to allow easy integration into your plant, production line, ERP, MES, SCADA with open protocols like OPC UA, PackML or SQL

#### Flexibility and scalability

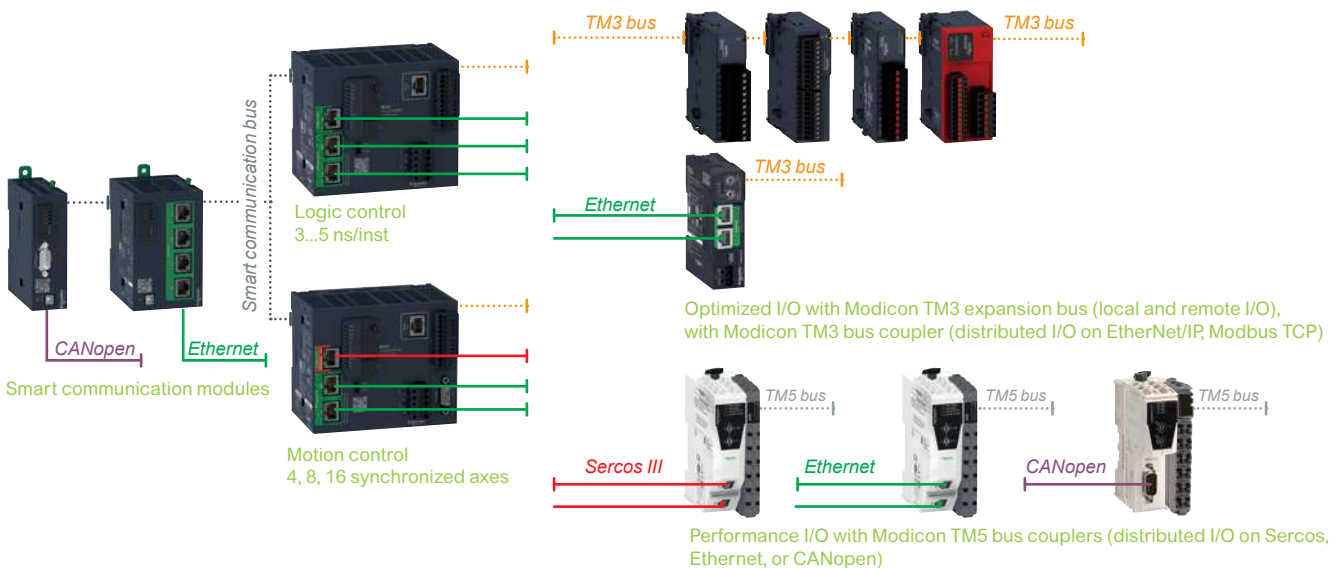

- > Automation “à la carte” with smart communication modules
- > Scalable performance - Manage logic applications, synchronized motion, embedded safety, and cloud connectivity all in one controller
- > I/O system adjusted to your needs, Optimized (Modicon TM3) for just enough architecture, or Performance (Modicon TM5) with high resolution, hot swap capability, etc.



Modicon M262, the IloT-ready controller for Logic and Motion machines

### Efficiency

Through smart engineering design

Modicon M262 Motion controller, Optimized local I/O with Modicon TM3

Modicon TM5 safety logic controller, Modicon TM5 Sercos interface module, Modicon TM5 safety I/O, Modicon TM7 safety I/O

Optimized I/O with Modicon TM3: Distributed I/O on Ethernet with TM3 bus coupler

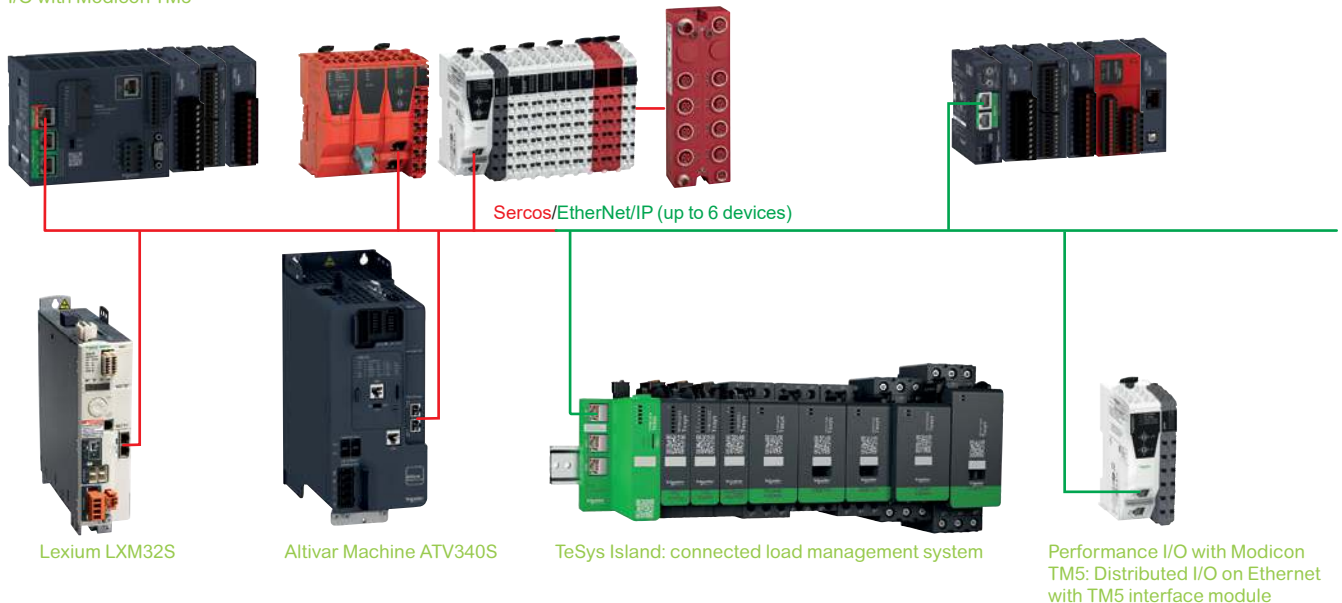

- > Benefit from real-time automation fieldbus with Sercos for fast motion control, safety functions, and openness to other devices
- > One cable simplifies the architecture and fieldbus wiring. Manage EtherNet/IP and Sercos devices on the same cable

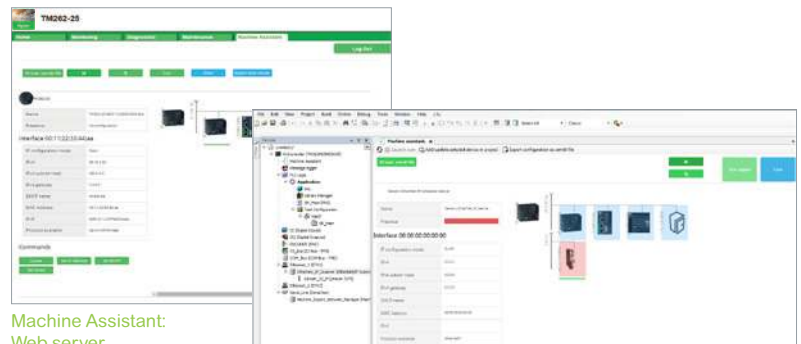

Machine Assistant: Web server

Machine Assistant: EcoStruxure Machine Expert

- > Simplified commissioning and diagnostics without software installation – “Machine Assistant”

### Protection

Embedded safety and security functions: Help to protect people, machines, data, and the environment



- > Meet safety regulations with embedded safety: Motion controller and safety logic controller
- > Cybersecurity, including encrypted communications, network separation, Achilles certification, user access/rights management, etc.
- > Green Premium certified, our ecolabel compliant with environmental regulations. Find more information on our [website](#)

# Logic/Motion controller – Modicon M262

## IIoT-ready for performance machines

### Modicon M262 Logic/Motion controllers



Food & Beverage applications



Packaging applications

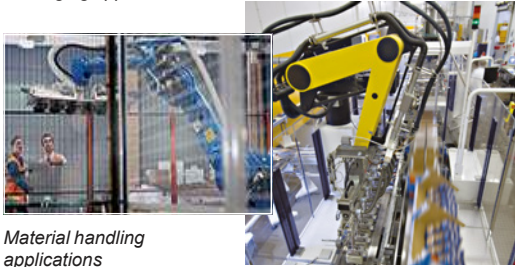

Material handling applications



Textile applications



Semiconductor



Hoisting applications

### Modicon M262 Logic/Motion controllers

#### Presentation

The Modicon M262 Logic/Motion controller offer is made for performance-demanding machines; M262 controllers are IIoT-ready (MQTT, HTTP, OPC UA, TLS, etc.) and combine logic, motion, and safety control applications.

- > TM262L for the logic control of multiple input and output arrangements
- > TM262M for the motion control of up to 16 synchronized axes, embedding a safety control application capable of attaining SIL3

#### Targeted applications

Modicon M262 Logic/Motion controllers are the ideal solution for industrial control processes in many fields of application, including the following:

- > Food & Beverage: From compact to modular – complete automation solutions for food and beverage machinery including robotics
- > Packaging: Schneider Electric has automated more than 100,000 machines worldwide with benchmark Modicon controllers and PacDrive platforms
- > Material handling: Complete solutions far beyond basic technologies - from logic, motion, and drive controllers to cartesian and delta picker solutions
- > Textile: Proven technology for automating high-speed processes in textile production
- > Hoisting: Proven architectures according to EN ISO 13849-1 and technology-specific function blocks enhance productivity in industrial and construction cranes
- > Semiconductor: A wide range of automation and digitization solutions enables machine builders to develop new machines and lines faster and with more flexibility
- > General purpose: For machines requiring IIoT embedded connectivity or encrypted communication

#### Embedded I/O

> Modicon M262 Logic/Motion controllers embed 4 fast digital inputs and 4 fast digital outputs, connected to the controller via screw terminals on the controller front face (1):

- Input types:
  - Sink/Source, 24 VDC, 8.1 mA, filtered
  - Digital: Raise an event task in 20 μs on rising or falling edge or both, latch, capture position on encoder
- Output types:
  - Source, 24 VDC, 50 to 200 mA, 3 μs
  - Fallback
- All inputs and outputs have status LEDs.

- > Modicon M262 motion controllers (TM262M●●●) embed an encoder input (SSI or incremental)
  - 5 VDC or 24 VDC configurable power supply, 150 mA
  - SSI100 or 200 kHz, 5 VDC

#### Extended I/O with modular I/O systems

- > Modicon M262 Logic/Motion controllers can be combined with Modicon TM3, Modicon TM5, and Modicon TM7 offers, allowing:
  - An increased number of I/O: with the Modicon TM3 expansion module offer, in local and remote I/O configurations
  - Extended I/O on communication networks:
    - Optimized distributed I/O islands on Ethernet with Modicon TM3
    - Performance distributed I/O islands with Modicon TM5 and Modicon TM7 on Ethernet or Sercos III

#### Equipment

Modicon M262 Logic/Motion controllers are equipped with:

- an integrated RTC
- a Run/Stop switch
- a NO alarm relay contact 24 VDC/2 A

(1) Removable screw terminals are supplied with the controllers.

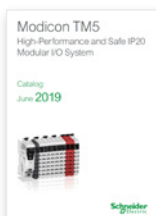
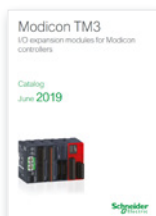

[DIA3ED2140109EN](#) [DIA3ED2131204EN](#) [DIA3ED2140405EN](#)

EtherNet/IP and Modbus TCP devices				
Logic/Motion controller	EtherNet/IP Max. number of devices	RPI (ms)	Modbus TCP Max. number of devices	EtherNet/IP + Modbus TCP Max. number of devices
TM262L10	64	40	64	96
TM262L20	64	20	64	128
TM262M15	64	40	64	96
TM262M25	64	20	64	128
TM262M35	64	20	64	128

Sercos, synchronized axes, motion, and one-cable devices						
Motion controller	No. of sync. axes	Sercos cycle time (ms)	Additional Sercos slaves	Total Sercos slaves	Additional EtherNet/IP slaves over Sercos	RPI (ms)
TM262M15	4	1	4	8	6	10
	4	2	12	16	6	10
TM262M25	8	2	8	16	6	6
	8	4	16	24	6	6
TM262M35	16	2	8	24	6	6
	16	4	24	40	6	6



EcoStruxure Machine Expert software



[DIA3ED2180701EN](#)

### Modicon M262 Logic/Motion controllers

#### Performance

- > The Modicon M262 Logic/Motion controllers have a dual-core processor:
  - Core 1 is dedicated exclusively to managing program tasks and offers maximum resources for real-time execution of the application code.
  - Core 2 is dedicated to executing communication tasks, which then have no further impact on the application execution performance.
- > They have a minimum cycle time of 500 µs, a 256 MB RAM memory that can store data and applications (32 MB for applications), and a 256 MB Flash memory for application and data backup. An SD card (up to 32 GB) can also be used in addition to embedded memories.
- > Performance of Modicon M262 controllers: 3 to 5 ns/instruction

#### Certifications and standards

- Modicon M262 controllers meet the requirements of the following certifications:
  - CE, cULus, RCM (1), EAC (1), Achilles
- Modicon M262 controllers conform to the following standards:
  - UL 61010-1, -2-201
  - CSA C22.2 No. 61010-1, CSA C22.2 No. 61010-2-201, CSA C22.2 No. 213
  - ANSI/ISA 12-12-01
  - EN 61131-2

#### Environmental characteristics

- Ambient operating temperature:
  - Horizontal mounting: - 20...60 °C (-4...140 °F)
  - Vertical mounting: - 20...50 °C (-4...122 °F)
  - Flat mounting: - 20...45 °C (-4...113 °F)
- Storage temperature: - 40...85 °C (- 40...185 °F)
- Relative humidity: 5...95% (non-condensing)
- Operating altitude: 0...2,000 m (0...6,562 ft)
- Storage altitude: 0...3,000 m (0...9,842 ft)

#### Power supply characteristics

Modicon M262 controllers are powered with a non-isolated 24 V DC power supply, and have built-in overload protection.

- Voltage limit: 20.4... 28.8 V  $\overline{\text{---}}$
- Immunity to micro-cuts (class PS-2): < 10 µs
- Max. consumption of controller during operation is 100 W.

#### Programming

- > EcoStruxure Machine Expert V1.1 is the machine builder's solution software for developing, configuring, and commissioning machine controllers such as Modicon M262 and the entire machine in a single software environment, including logic control, motion control, remote I/O systems, safety control, motor control, HMI design, and related network automation functions.
- > This software environment covers the entire engineering life-cycle with:
  - Collaborative team work and version management
  - IIoT and standard libraries integration
  - Automatic testing (ETEST) and simulation
  - Code quality control (Machine Code Analysis)
  - Deployment and commissioning
  - Diagnostics and remote services
- > In addition, EcoStruxure Machine Expert interacts with various engineering tools via open interfaces.
  - IEC 61131-3 programming languages: Instruction List (IL), Ladder Diagram (LD), Function Block Diagram (FBD), Sequential Function Chart/Grafcet (SFC), Structured Text (ST), and CFC (Continuous Function Chart)
  - Integrated fieldbus configurators
  - Expert diagnostic and debugging functions
  - Motion design, according to PLCopen Motion Control, as well as multiple capabilities for commissioning, maintenance, and visualization

(1) Pending

# Logic/Motion controller – Modicon M262

## IIoT-ready for performance machines

### Modicon M262 Logic/Motion controllers

#### Modicon M262 Logic/Motion controllers

##### Housing

- > With their compact dimensions, Modicon M262 Logic/Motion controllers optimize the size of wall-mounted and floor-standing control system enclosures. Format (w x d x h): 125 x 90 x 100 mm (4.92 x 3.54 x 3.93 in.)
- > Modicon M262 Logic/Motion controllers can be mounted on DIN rail (┌┐) or panel (┌┐).
- > A QR code, printed on the front face of controllers and smart communication modules, gives a link to the product's SE maintenance page and its unique serial number (S/N).
- > For easier identification in the field, the product's commercial reference is printed on the front of the controller.
- > A slot for an industrial memory card is available on the controller's front face: SD card up to 2 GB or SDHC card up to 32 GB. **TMASD** industrial SD memory cards are available for backing up and transferring applications, data logging, and firmware updates.

##### Connecting a Modicon M262 controller to devices

- > There is a USB Mini-B isolated port for programming (with Machine Expert, FTP, HTTP and Modbus protocols).
- > A smart communication bus allows connection of up to three smart communication modules, assembled by simple interlocking on the left-hand side of the controller. The smart communication bus embeds the power supply for the smart communication modules. Two types of smart communication module are available for CANopen and Ethernet connections.



- 1 TMSCO1 CANopen smart communication module
- 2 TMSES4 Ethernet smart communication module
- 3 M262 Logic/Motion controller

Maximum installation: A maximum of one TMSCO1 with two TMSES4 smart communication modules is allowed. TMSCO1 is always the last module on the left. Alternatively, a maximum of three TMSES4 smart communication modules can be connected.

##### Connecting a Modicon M262 controller to the Modicon TM3 I/O system

- > A **TM3** bus port located on the right-hand side of the Modicon M262 controller allows connection of any of the TM3 expansion modules for local, remote, or distributed I/O configurations:
  - Local I/O: 7x Modicon TM3 expansion modules (max. configuration)
  - Remote I/O: + 7x remote modules (equals 14x TM3 modules: 7x local + 7x remote)
  - Distributed I/O: up to 64x TM3 bus coupler (EtherNet/IP or Modbus TCP), allowing 14x TM3 I/O modules by bus coupler (EtherNet/IP)

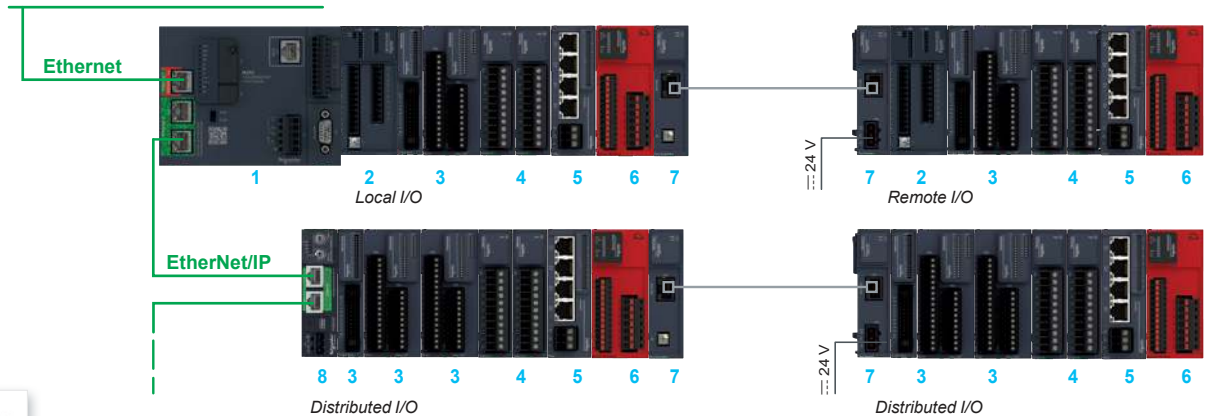

- 1 Modicon M262 Logic/Motion controller
- 2 TM3 expert counter module (event management available on first two slots after Modicon M262 controller only)
- 3 Digital I/O modules
- 4 Analog I/O modules
- 5 Expert module for controlling TeSys motor starters
- 6 Functional safety modules
- 7 Bus expansion modules (transmitter and receiver) and bus expansion cable
- 8 TM3BCEIP bus coupler module (several bus coupler are allowed)

(1) For vertical or flat mounting, please consult our Customer Care Center.



DIA3ED2140109EN

#### Modicon M262 Logic/Motion controllers

##### Connecting a Modicon M262 controller to Modicon TM5 and TM7 I/O systems

- > On the embedded Ethernet ports of the Modicon M262 Logic/Motion controller, to extend its capacity with distributed I/O systems that provide flexibility and scalability for machines:
  - With Modicon TM5, IP20 Performance range of I/O designed for complex machines
  - With Modicon TM7, IP67 Performance range of I/O designed to work in harsh environments

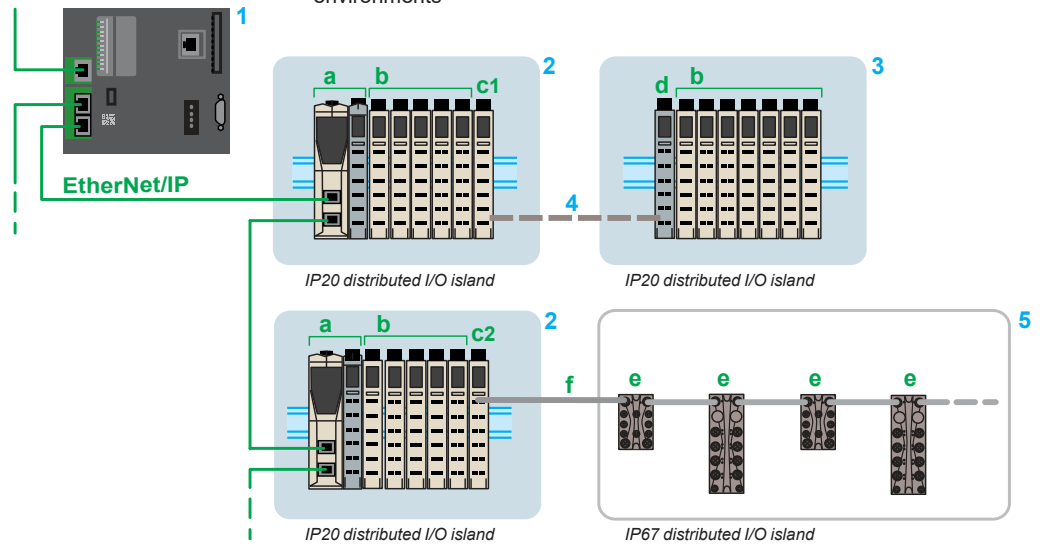

- 1 Modicon M262 Logic/Motion controller: EtherNet/IP network masters
- 2 TM5 EtherNet/IP interface module (slave) (a) + TM5 modules (b) + TM5SBET1 (c1)/TM5SBET7 (c2) transmitter modules
- 3 TM5SBER2 receiver module (d) + TM5 I/O modules (b)
- 4 TM5 expansion bus: TCSXCNNXN100 remote I/O connection cable
- 5 Modicon TM7 blocks (digital or analog I/O) (e) + TM7TCSXC�E bus expansion cable (f)

##### Connecting a Modicon M262 Motion controller to Modicon TM5 and TM7 safety I/O systems

- > On the embedded Sercos port of the Modicon M262 motion controller: Embedded safety with the TM5CSLC safety logic controller, Modicon TM5 safety I/O, and Modicon TM7 safety I/O.

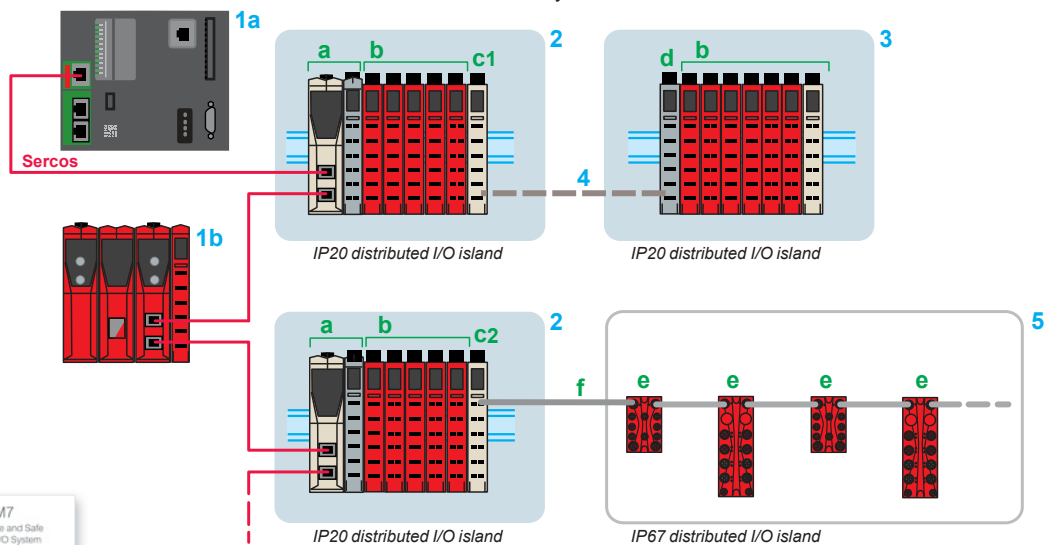

- 1 a Modicon M262 Logic/Motion controller: Sercos bus master
- b Modicon TM5CSLC safety logic controller: Sercos bus slave
- 2 TM5 interface module (a) + TM5 safety I/O modules (b) + TM5SBET1 (c1)/TM5SBET7 (c2) transmitter modules
- 3 TM5SBER2 receiver module (d) + TM5 safety I/O modules (b)
- 4 TM5 expansion bus: TCSXCNNXN100 remote I/O connection cable
- 5 Modicon TM7 safety I/O blocks (e) + TM7TCSXC�E bus expansion cable (f)

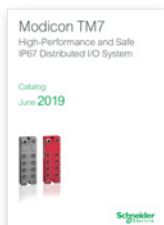
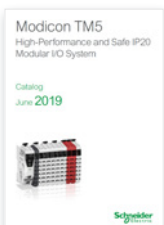

[DIA3ED2131204EN](#)

[DIA3ED2140405EN](#)

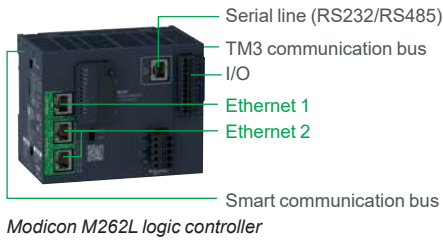

Modicon M262L logic controller

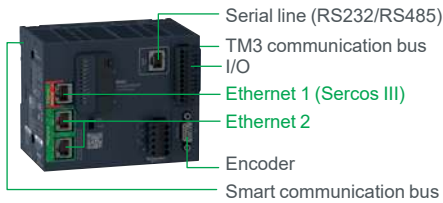

Modicon M262M motion controller

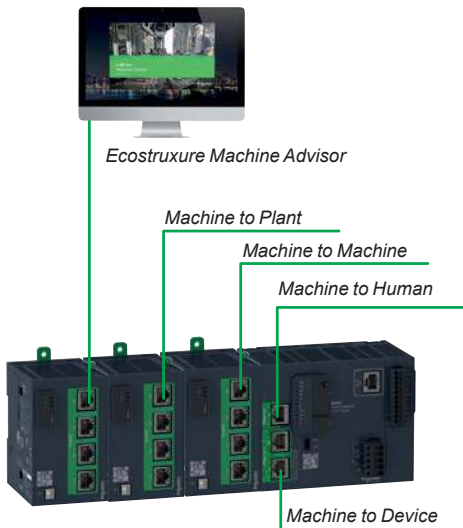

Modicon M262L logic controller with 3x TMSES4 smart communication modules (maximum configuration)

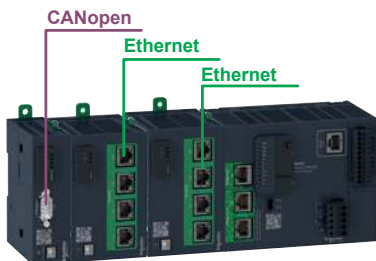

Modicon M262L logic controller with 3 smart communication modules: 2x TMSES4, and one TMSCO1 (always the last module on the left)



[DIA3ED2160105EN](#)



[DIA3ED2160104EN](#)

### Modicon M262 Logic/Motion controllers

#### Embedded communication

Modicon M262 Logic/Motion controllers embed:

- Two Ethernet-based networks:
  - Ethernet 1 with one RJ45 connector: 100 Mbps with EtherNet/IP, Modbus TCP; plus Sercos III on motion controllers
  - Ethernet 2 with 2x RJ45 connectors: 1 GB/s with EtherNet/IP and Modbus TCP
- One isolated serial port with one RJ45, 0.3 to 115 kBauds, RS232 or RS485, with Modbus, ASCII, and Machine Expert protocols
- One smart communication bus, for TMS smart communication modules (Ethernet and CANopen)
- One TM3 communication bus
- One I/O port

Modicon M262 Motion controllers embed one encoder connector.

#### Ethernet services

Services are available on Modicon M262 controllers and on the Ethernet smart communication module.

- Scanner manager on EtherNet/IP and Modbus TCP
- EtherNet/IP Adapter
- DHCP Client/Server
- Data exchange – IEC VAR ACCESS
- Modbus TCP Client/Server and Modbus TCP Client device
- SNMP Client/Server
- FTP Client/Server
- SQL Client
- Send/receive email based on TCP/UDP Lib
- Web server and Web visu
- OPC UA Server
- DNS Client
- MQTT, HTTP
- Sntp
- TLS
- Machine Assistant

For connection cables and accessories for Ethernet network, please consult our catalog ref. [DIA3ED2160105EN](#).

#### Additional communication

With the use of two smart communication modules, the controllers benefit from optional connections:

- One CANopen connection
  - Up to three Ethernet connections
- > **TMSCO1** smart communication module - adds a CANopen port for CANopen master communication.
- The link can be configured between 20 kbps and 1 Mbps and supports up to 63 slaves.
  - Architectures based on CANopen are used to distribute I/O modules as close to the sensors and actuators as possible, thus reducing wiring costs and times, and to communicate with different devices such as variable speed drives, servo drives, etc.
  - The CANopen configurator is integrated in the EcoStruxure Machine Expert software and can also be used to import standard description files in EDS format.
  - For CANopen connection cables and accessories, please consult our catalog ref. [DIA3ED2160104EN](#).
- > **TMSES4** smart communication module - allows up to 3 additional Ethernet networks:
- 4x RJ45 switched ports as hub
  - IloT-ready
  - Network isolation
  - Ethernet Gigabyte exchange
  - Cybersecurity Achilles L1

#### Certifications and standards

- > TMS smart communication modules meet the requirements of the following certifications: CE, cULus, RCM (1), EAC (1)
- > TMS smart communication modules conform to the following standards:
  - UL 61010-1, UL 61010-2-201
  - CSA C22.2 No. 61010-1, CSA C22.2 No. 61010-2-201, CSA C22.2 No. 213
  - ANSI/ISA 12-12-01
  - EN 61131-2

(1) Pending

## Modicon M262 Logic/Motion controllers

### Embedded safety

#### Modicon TM5CSLC safety logic controller

- > Modicon TM262M●●● motion controllers embed the Sercos protocol on their Ethernet 1 port, so that they can manage Modicon TM5CSLC safety logic controllers, set as slave on Sercos, Modicon TM5 safety I/O modules, and Modicon TM7 safety I/O blocks.



Modicon TM262M●●● controlling TM5CSLC logic controller, TM5 safety I/O modules, and TM7 safety I/O blocks on Sercos III

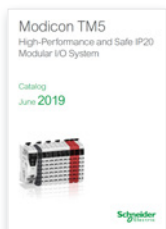

[DIA3ED2131204EN](#)

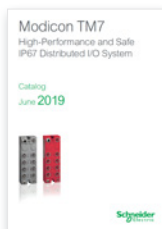

[DIA3ED2140405EN](#)

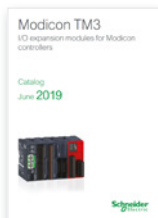

[DIA3ED2140109EN](#)

#### Modicon TM3 functional safety modules

- > Modicon M262 Logic/Motion controllers embed a TM3 bus for managing Modicon TM3 functional safety modules.

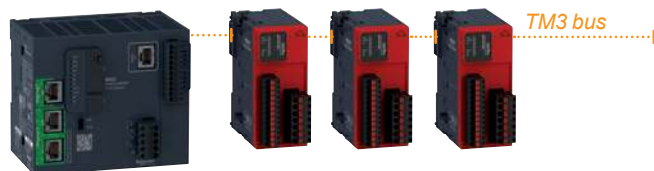

Modicon M262 Logic/Motion controller controlling TM3 functional safety modules: local I/O connected to the TM3 bus

#### Safety offers by Schneider electric

#### Preventa XPSMCM modular safety controllers

- > Preventa XPSMCM modular safety controllers on EtherNet/IP network (or Modbus RTU, Modbus/TCP, EtherCat, CANopen and ProfibusDP fieldbus)

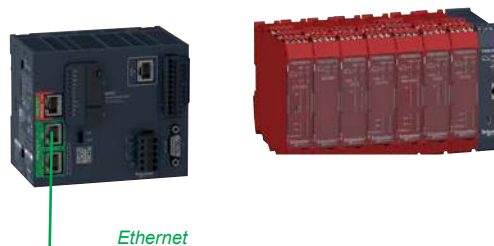

Modicon TM262M●●● controlling Preventa XPSMCM modular safety controllers on Ethernet network



[DIA3ED2140901EN](#)

Applications	Logic control		Motion control		
					
<b>Embedded I/O</b>	4 fast digital inputs	4 fast digital inputs	4 fast digital inputs	4 fast digital inputs	4 fast digital inputs
	4 fast digital outputs	4 fast digital outputs	4 fast digital outputs	4 fast digital outputs	4 fast digital outputs
<b>Encoder input</b>	–	–	Incremental/SSI, 5 VDC/24 VDC	Incremental/SSI, 5 VDC/24 VDC	Incremental/SSI, 5 VDC/24 VDC
<b>Synchronized axes</b>	–	–	4 (1 ms)	8 (2 ms)	16 (2 ms)
<b>Performance</b>	5 ns/inst	3 ns/inst	5 ns/inst	3 ns/inst	3 ns/inst
<b>Certifications</b>	CE, cULus, RCM (1), EAC (1), Achilles		CE, cULus, RCM (1), EAC (1), Achilles		
<b>Standards</b>	UL 61010-1, -2-201 CSA C22.2 No. 61010-1, CSA C22.2 No. 61010-2-201, CSA C22.2 No. 213 ANSI/ISA 12-12-01 EN 61131-2		UL 61010-1, -2-201 CSA C22.2 No. 61010-1, CSA C22.2 No. 61010-2-201, CSA C22.2 No. 213 ANSI/ISA 12-12-01 EN 61131-2		
<b>Ambient air temperature for operation</b>	<ul style="list-style-type: none"> <li>&gt; Horizontal mounting: - 20 °C...60 °C (-4...140 °F)</li> <li>&gt; Vertical mounting: - 20 °C...50 °C (-4...122 °F)</li> <li>&gt; Flat mounting: - 20 °C...45 °C (-4...113 °F)</li> </ul>		<ul style="list-style-type: none"> <li>&gt; Horizontal mounting: - 20 °C...60 °C (-4...140 °F)</li> <li>&gt; Vertical mounting: - 20 °C...50 °C (-4...122 °F)</li> <li>&gt; Flat mounting: - 20 °C...45 °C (-4...113 °F)</li> </ul>		
<b>Embedded communication</b>	<p>Ethernet</p> <ul style="list-style-type: none"> <li>&gt; Ethernet 1 with one RJ45 port : 100 Mbps with EtherNet/IP and Modbus TCP</li> <li>&gt; Ethernet 2 with two RJ45 ports: 1 Gbps with EtherNet/IP and Modbus TCP</li> </ul> <p>Services</p> <p>Scanner manager on EtherNet/IP and Modbus TCP, EtherNet/IP Adapter, DHCP Client/Server, Data exchange - IEC VAR ACCESS, Modbus TCP Client/Server, Modbus TCP Client device, SNMP Client/Server, FTP Client/Server, Web server and Web visu, SQL Client, Send/receive email based on TCP/UDP Library, Web server, OPC UA Server, DNS Client, MQTT, HTTP, SNMP, TLS, Machine Assistant</p> <p>USB</p> <p>1x USB Mini-B isolated (programming, virtual port, FTP, HTTP, Modbus)</p> <p>Memory card</p> <p>Secure Digital card (SD up to 2 GB or SDHC up to 32 GB)</p> <p>Serial line</p> <p>One isolated serial link (RJ45): RS232 or RS485 (configurable), with RTU, Modbus SL, ASCII, and Machine Expert protocols</p>		<p>Ethernet</p> <ul style="list-style-type: none"> <li>&gt; Ethernet 1 with one RJ45 port : 100 Mbps with EtherNet/IP, Modbus TCP, and Sercos III</li> <li>&gt; Ethernet 2 with two RJ45 ports: 1 Gbps with EtherNet/IP and Modbus TCP</li> </ul> <p>Services</p> <p>Scanner manager on EtherNet/IP and Modbus TCP, EtherNet/IP Adapter, DHCP Client/Server, Data exchange - IEC VAR ACCESS, Modbus TCP Client/Server, Modbus TCP Client device, SNMP Client/Server, FTP Client/Server, Web server and Web visu, SQL Client, Send/receive email based on TCP/UDP Library, Web server, OPC UA Server, DNS Client, MQTT, HTTP, SNMP, TLS, Machine Assistant</p> <p>USB</p> <p>1x USB Mini-B isolated (programming, virtual port, FTP, HTTP, Modbus)</p> <p>Memory card</p> <p>Secure Digital card (SD up to 2 GB or SDHC up to 32 GB)</p> <p>Serial line</p> <p>One isolated serial link (RJ45): RS232 or RS485 (configurable), with RTU, Modbus SL, ASCII, and Machine Expert protocols</p>		
<b>Additional communication</b>	<p>Ethernet</p> <p>Up to three additional Ethernet networks (EtherNet/IP Slave and Modbus TCP) with TMSES4 smart communication module:</p> <ul style="list-style-type: none"> <li>- 4 switched RJ45 ports as hub</li> <li>- IIoT-ready</li> <li>- Network isolation with management from M262</li> <li>- Ethernet Gigabyte exchange</li> <li>- Cybersecurity Achilles L1</li> </ul> <p>CANopen</p> <p>One CANopen port for CANopen master communication with TMSCO1 smart communication module</p>		<p>Ethernet</p> <p>Up to three additional Ethernet networks (EtherNet/IP Slave and Modbus TCP) with TMSES4 smart communication module:</p> <ul style="list-style-type: none"> <li>- 4 switched RJ45 ports as hub</li> <li>- IIoT-ready</li> <li>- Network isolation with management from M262</li> <li>- Ethernet Gigabyte exchange</li> <li>- Cybersecurity Achilles L1</li> </ul> <p>CANopen</p> <p>One CANopen port for CANopen master communication with TMSCO1 smart communication module</p>		
<b>Compatible I/O systems</b>	<p>For local and remote I/O systems</p> <ul style="list-style-type: none"> <li>&gt; Modicon TM3 (2): <ul style="list-style-type: none"> <li>- Expert modules (upcounting, downcounting, allow event (TM3XFHSC) on 2 first slots)</li> <li>- Analog modules</li> <li>- Digital modules</li> <li>- Embedded safety with TM3 functional safety modules</li> </ul> </li> <li>&gt; Modicon TM3 Ethernet bus coupler</li> <li>&gt; Modicon TM5 Ethernet network interface module (3)</li> <li>&gt; Modicon TM5 Sercos bus interface module (3), Embedded safety with TM5CSLC safety logic controllers, Modicon TM5 safety I/O modules</li> <li>&gt; Modicon TM7 safety I/O blocks (4)</li> <li>&gt; Modicon TM5 CANopen bus interface module (3)</li> <li>&gt; Modicon TM7 CANopen interface block (4)</li> </ul> <p>For distributed I/O on Ethernet network</p> <p>on Sercos bus</p> <p>on CANopen bus</p>		<p>For local and remote I/O systems</p> <ul style="list-style-type: none"> <li>&gt; Modicon TM3 (2): <ul style="list-style-type: none"> <li>- Expert modules (upcounting, downcounting, allow event (TM3XFHSC) on 2 first slots)</li> <li>- Analog modules</li> <li>- Digital modules</li> <li>- Embedded safety with TM3 functional safety modules</li> </ul> </li> <li>&gt; Modicon TM3 Ethernet bus coupler</li> <li>&gt; Modicon TM5 Ethernet network interface module (3)</li> <li>&gt; Modicon TM5 Sercos bus interface module (3), Embedded safety with TM5CSLC safety logic controllers, Modicon TM5 safety I/O modules</li> <li>&gt; Modicon TM7 safety I/O blocks (4)</li> <li>&gt; Modicon TM5 CANopen bus interface module (3)</li> <li>&gt; Modicon TM7 CANopen interface block (4)</li> </ul> <p>For distributed I/O on Ethernet network</p> <p>on Sercos bus</p> <p>on CANopen bus</p>		
<b>Configuration software</b>	EcoStruxure Machine Expert V1.1 software (5)		EcoStruxure Machine Expert V1.1 software (5)		
<b>Type of controller</b>	<b>TM262L10MESE8T</b>	<b>TM262L20MESE8T</b>	<b>TM262M15MESS8T</b>	<b>TM262M25MESS8T</b>	<b>TM262M35MESS8T</b>
<b>Page</b>	19		19		

(1) Pending  
(2) Consult catalog ref. [DIA3ED2140109EN](#)  
(3) Consult catalog ref. [DIA3ED2131204EN](#)  
(4) Consult catalog ref. [DIA3ED2140405EN](#)  
(5) Consult catalog ref. [DIA3ED2180701EN](#)



# Logic/Motion controller – Modicon M262

## IIoT-ready for performance machines

Modicon M262 controllers  
TMS smart communication modules

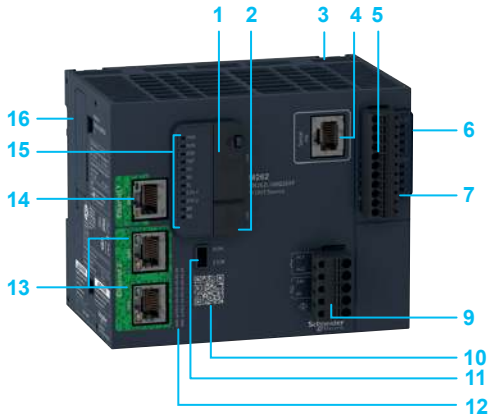

Modicon TM262L logic controller

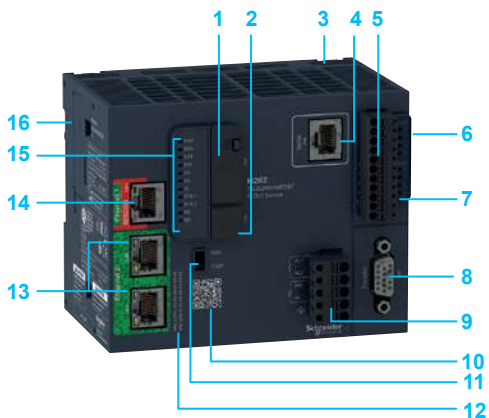

Modicon TM262M motion controller

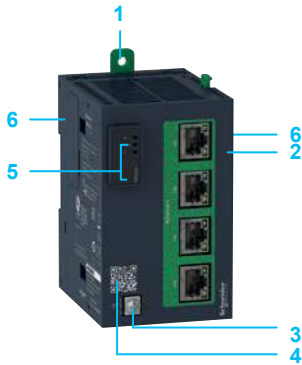

TMSES4 Ethernet smart communication module

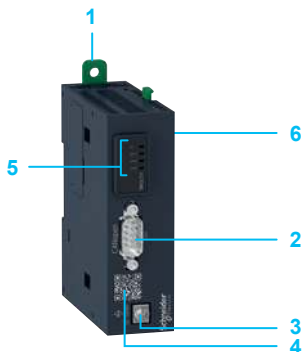

TMSCO1 CANopen smart communication module

### Description

#### Modicon M262 controllers (1)

- 1 SD card slot marked CN4 (behind a protective cover)
- 2 USB Mini-B programming port marked CN5 (behind a protective cover)
- 3 Clip-on lock for 35 mm (1.38 in.) DIN rail
- 4 RJ45 port marked CN6 for Serial line
- 5 Removable spring terminal connector marked CN8 for inputs/outputs
- 6 On right side of the controller: TM3 bus connector
- 7 I/O status LEDs
- 8 On TM262M: Sub-D connector marked CN9 for encoder
- 9 Removable spring terminal connector marked CN7 (provided with the controller) for 24 VDC power supply input/alarm relay
- 10 QR code: link to SE product maintenance page and unique serial number (S/N)
- 11 Run/Stop switch
- 12 MAC addresses written on Modicon M262 front face
- 13 2x Ethernet switched ports (type RJ45) marked CN2 and CN3
- 14 On TM262L logic controllers: 1 Ethernet port (type RJ45) marked CN1  
On TM262M motion controllers: 1 Ethernet/Sercos port (type RJ45) marked CN1
- 15 Status LEDs
- 16 On left side of controller: smart communication bus connector

#### TMS smart communication modules

- 1 Clip-on lock for 35 mm (1.38 in.) DIN rail
- 2 On TMSES4: 4x Ethernet switched ports, type RJ45 (10 BASE-T -100-1000 BASE-TX)  
On TMSCO1: 1 CANopen port, type Sub-D 9-way
- 3 Functional ground connector
- 4 QR code: link to SE product maintenance page and unique serial number (S/N)
- 5 Status LEDs
- 6 Smart communication bus connector:
  - on both sides of TMSES4 Ethernet smart communication module
  - on right side of TMSCO1 CANopen smart communication module only

(1) Modicon M262 controllers are supplied with removable spring terminal connectors for connecting the I/O and power supply.

Note: It is advisable to use the TM2XMTGB grounding plate, which simplifies connection of the analog sensor and actuator cable shielding. This shielding must be connected to the device's functional ground.

## Logic/Motion controller – Modicon M262 IIoT-ready for performance machines

Modicon M262 controllers  
TMS smart communication modules



TM262L10MESE8T



TM262M15MESS8T



TMSES4



TMSCO1



TMA262SET8S TMA262SET8G

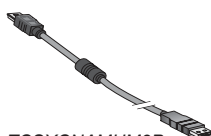

TCSXCNAMUM3P



[DIA3ED2140109EN](#)

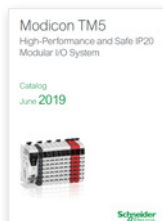

[DIA3ED2131204EN](#)

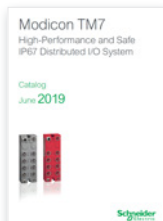

[DIA3ED2140405EN](#)



[DIA3ED2180701EN](#)

### References

#### Modicon M262 controllers (1) 24 V $\square$ power supply

I/O	Execution speed ns/Boolean instructions	Max. no. of synchronized axes	Embedded communication			Reference	Weight kg/lb
			Ethernet	Sercos	Serial link		
<b>Logic controllers</b>							
4 fast digital inputs/4 fast digital outputs	5	–	2	–	1	<a href="#">TM262L10MESE8T</a>	0.665 1.466
	3	–	2	–	1	<a href="#">TM262L20MESE8T</a>	0.665 1.466

#### Motion controllers

4 fast digital inputs/4 fast digital outputs	5	4 axes	2	1	1	<a href="#">TM262M15MESS8T</a>	0.670 1.477
+ 1 encoder input (incremental/SSI, 5 VDC/24 VDC)	3	8 axes	2	1	1	<a href="#">TM262M25MESS8T</a>	0.670 1.477
	3	16 axes	2	1	1	<a href="#">TM262M35MESS8T</a>	0.670 1.477

#### TMS smart communication modules for Modicon M262 controllers

Designation	Description	Reference	Weight kg/lb
<b>Ethernet smart communication module</b>	For adding an Ethernet network Equipped with 4x RJ45 switched ports: - IIoT-ready - Network isolation - Ethernet Gigabyte exchange - Cybersecurity Achilles L1	<a href="#">TMSES4</a>	0.403 0.888
<b>CANopen smart communication module</b>	For adding a CANopen master network Equipped with a 9-way SUB-D connector	<a href="#">TMSCO1</a>	0.150 0.330

#### Spare parts for Modicon M262 controllers

Designation	Use for	Reference	Weight kg/lb
<b>Set of screw connectors</b>	I/O and power supply	<a href="#">TMA262SET8S</a>	
<b>Set of spring connectors</b>	I/O and power supply	<a href="#">TMA262SET8G</a>	

#### Accessories for Modicon M262 controllers

Designation	Description	Reference	Weight kg/lb
<b>Secure Digital card</b>	Application backup and program transfer Capacity: 256 MB	<a href="#">TMASD1</a>	0.004/ 0.009
<b>Grounding plate</b>	Support equipped with 10 male Faston connectors for connecting the cable shielding (via 6.35 mm (0.25 in.) connectors, not supplied) and the functional ground (FG)	<a href="#">TM2XMTGB</a>	0.045/ 0.099

#### Connection cables

Designation	Use from	to	Length m (ft)	Reference	Weight kg/lb
<b>Programming cables</b>	USB port on PC	USB Mini-B port on Modicon M262 controllers	3 (0.98)	<a href="#">TCSXCNAMUM3P</a> (3)	0.065/ 0.143
			1.8 (5.90)	<a href="#">BMXXCAUSBH018</a>	0.065/ 0.143

#### Expansion modules

<b>Modicon TM3 I/O expansion modules</b>	Please consult the catalog ref. <a href="#">DIA3ED2140109EN</a>
<b>Modicon TM5, High-Performance and Safe IP20 Modular I/O System</b>	Please consult the catalog ref. <a href="#">DIA3ED2131204EN</a>
<b>Modicon TM7, High-Performance and Safe IP67 Distributed I/O System</b>	Please consult the catalog ref. <a href="#">DIA3ED2140405EN</a>

#### Programming software

<b>EcoStruxure Machine Expert V1.1</b>	Please consult the catalog ref. <a href="#">DIA3ED2180701EN</a>
--	---

(1) Modicon M262 controllers are supplied with removable spring terminal connectors for the I/O and power supply connections.

(2) Ethernet embeds EtherNet/IP and Modbus TCP, only one Master allowed, in combination with Sercos, Eth. 1 allows EtherNet/IP, Modbus TCP, and Sercos on same port and cable (one-cable).

(3) Unshielded, non-grounded cable. For use on temporary connections only. For permanent connections, use cable reference BMXXCAUSBH018.

**Modicon M262 Logic controller in a Tested Validated & Documented Architecture (TVDA)**

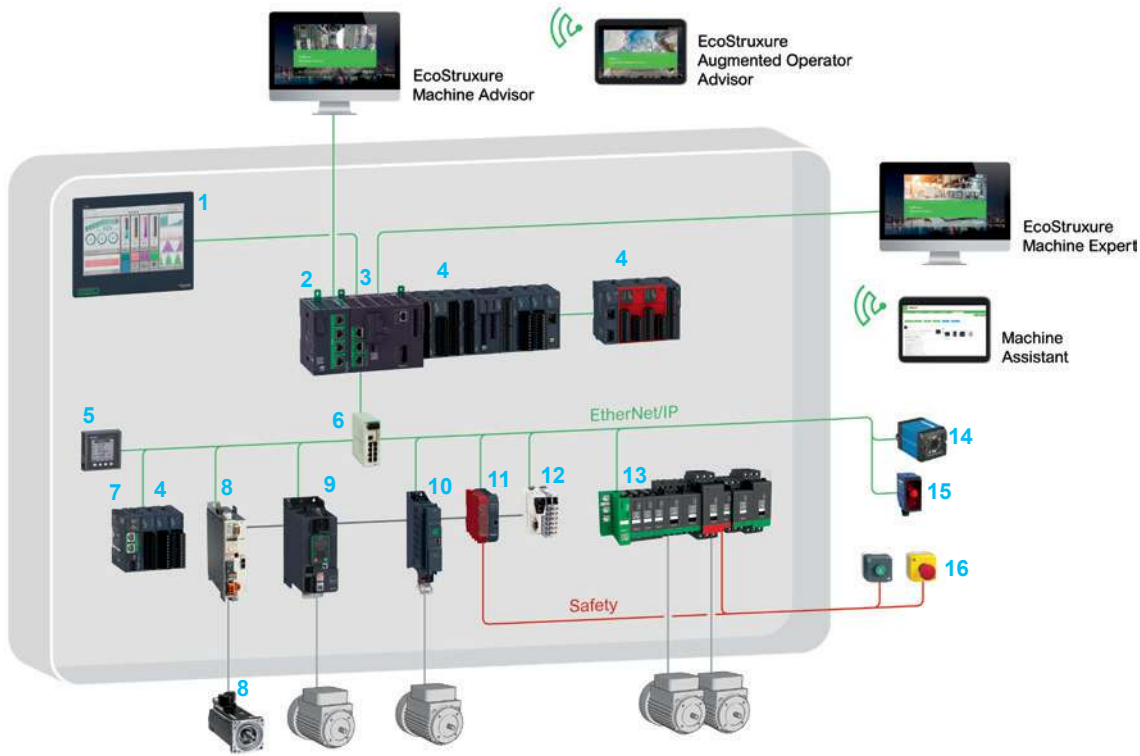

**Solution breakdown (1)**

- 1 Magelis iPC: Touchscreen display
- 2 Modicon TMSES4 Ethernet smart communication module
- 3 Modicon M262 Logic controller
- 4 Modicon TM3 expansion modules (digital, analog, Expert, and safety I/O)
- 5 Power Meter
- 6 ConneXium Ethernet switch
- 7 Modicon TM3 Ethernet bus coupler
- 8 Lexium 32M servo drives and BMH/BSH servo motor
- 9 Altivar Machine ATV340S variable speed drive
- 10 Altivar Machine ATV320 variable speed drive
- 11 Preventa XPSMCM modular safety controller
- 12 Modicon TM5 Ethernet interface module
- 13 TeSys island load management system
- 14 Bar code reader
- 15 Telemecanique Sensors proximity sensors
- 16 Harmony® XB5 plastic pushbutton and Emergency stop



(1) Please refer to our catalogs on [Digi-Cat](#) (download Digi-Cat)

#### Modicon M262 Motion controller in a Tested Validated & Documented Architecture (TVDA)

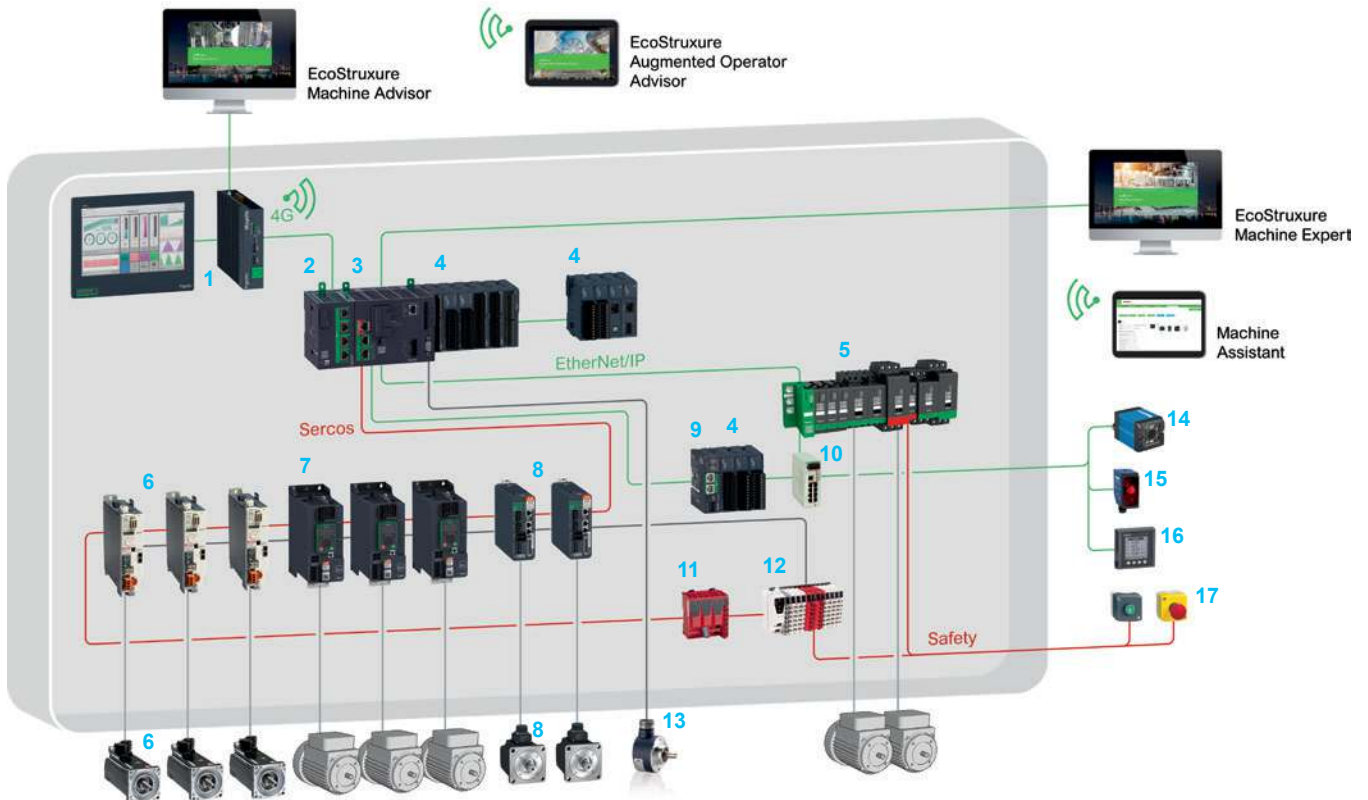

#### Solution breakdown (1)

- |  |   |
|--|---|
| <ul style="list-style-type: none"> <li>1 Magelis iPC: Touchscreen display and IIoT Edge Box</li> <li>2 Modicon TMSES4 smart communication module</li> <li>3 Modicon M262 Motion controller</li> <li>4 Modicon TM3 expansion modules (digital, analog, and Expert I/O)</li> <li>5 TeSys island load management system</li> <li>6 Lexium 32S servo drives and BMH/BSH servo motors</li> <li>7 Altivar Machine ATV340S variable speed drives</li> <li>8 Lexium 28 servo drives and BCH2 servo motors</li> <li>9 Modicon TM3 Ethernet bus coupler</li> </ul> | <ul style="list-style-type: none"> <li>10 ConneXium Ethernet switch</li> <li>11 Modicon TM5CSLC safety logic controller</li> <li>12 Modicon TM5: Sercos interface module and I/O modules (digital, analog, and safety I/O)</li> <li>13 Encoders</li> <li>14 Bar code reader</li> <li>15 Telemecanique Sensors proximity sensors</li> <li>16 Power Meter</li> <li>17 Harmony® XB5 plastic pushbutton and Emergency stop</li> </ul> |
|--|---|



(1) Please refer to our catalogs on [Digi-Cat](#) (download Digi-Cat)

**B**

[BMXXCAUSBH018](#) 19

**T**

[TCSXCNAMUM3P](#) 19

[TM2XMTGB](#) 19

[TM262L10MESE8T](#) 19

[TM262L20MESE8T](#) 19

[TM262M15MESS8T](#) 19

[TM262M25MESS8T](#) 19

[TM262M35MESS8T](#) 19

[TMA262SET8G](#) 19

[TMA262SET8S](#) 19

[TMASD1](#) 19

[TMSCO1](#) 19

[TMSES4](#) 19



[www.schneider-electric.com/msx](http://www.schneider-electric.com/msx)

#### Schneider Electric Industries SAS

Head Office  
35, rue Joseph Monier  
F-92500 Rueil-Malmaison  
France

The information provided in this documentation contains general descriptions and/or technical characteristics of the performance of the products contained herein. This documentation is not intended as a substitute for and is not to be used for determining suitability or reliability of these products for specific user applications. It is the duty of any such user or integrator to perform the appropriate and complete risk analysis, evaluation and testing of the products with respect to the relevant specific application or use thereof. Neither Schneider Electric nor any of its affiliates or subsidiaries shall be responsible or liable for misuse of the information contained herein.

Design: Schneider Electric  
Photos: Schneider Electric